

俯视图

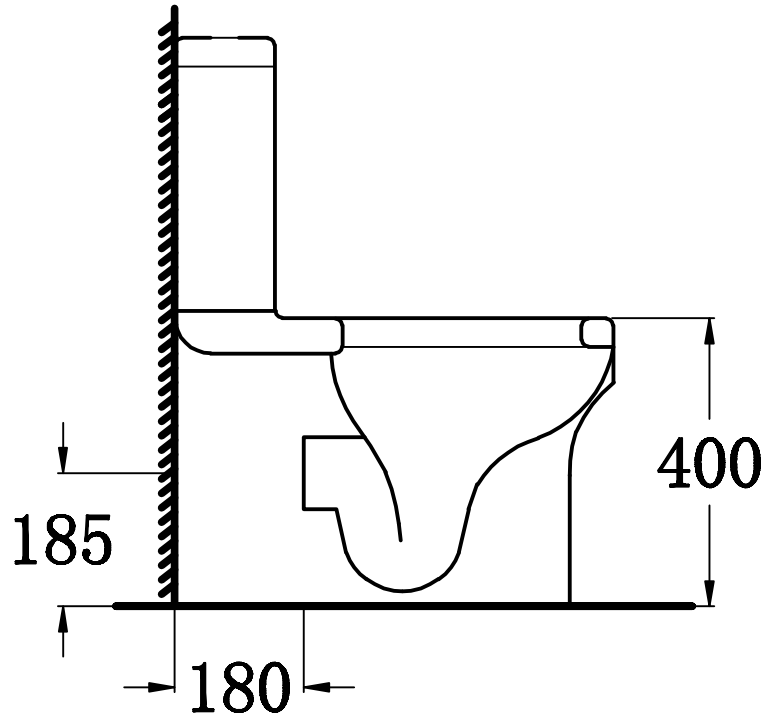

剖面图

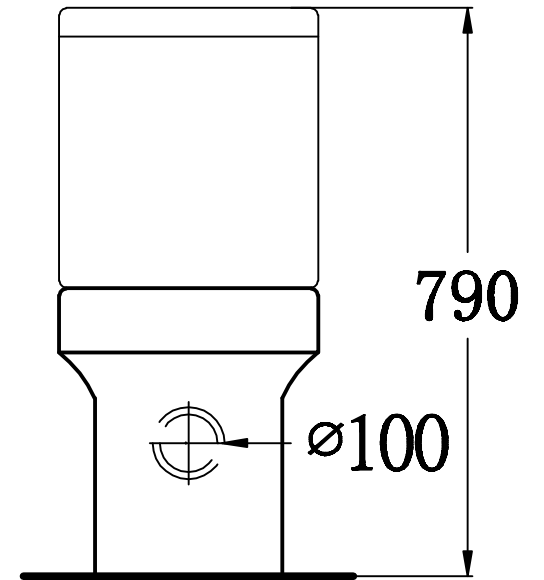

主视图

说明：接受±5mm公差

华乐诗卫浴有限公司 Walrus Building Product Ltd.			
型号 Model No.	WR-120126.1B	设计 Designed by	
名称 Product Description		制图 Drawn by	
重量 Weight		审核 Audited by	
比例 Scale	1:10	审核 Revised by	
日期 Date		批准 Approved by	